

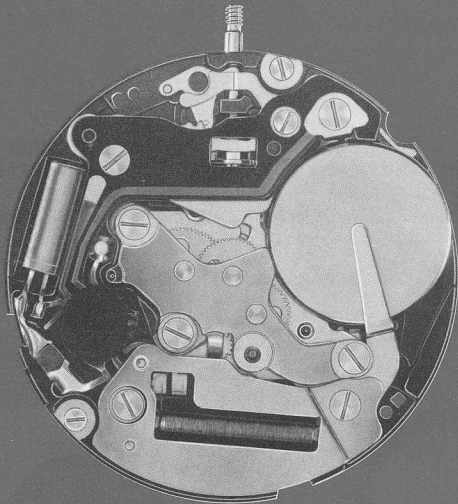

# ISAQUARTZ



Cage

Frame

Cadran

Dial

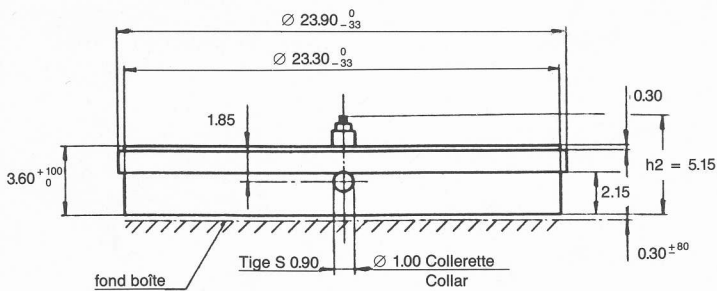

Hauteur supplémentaire avec bride positive supérieure  
Additional thickness if covering bride is used

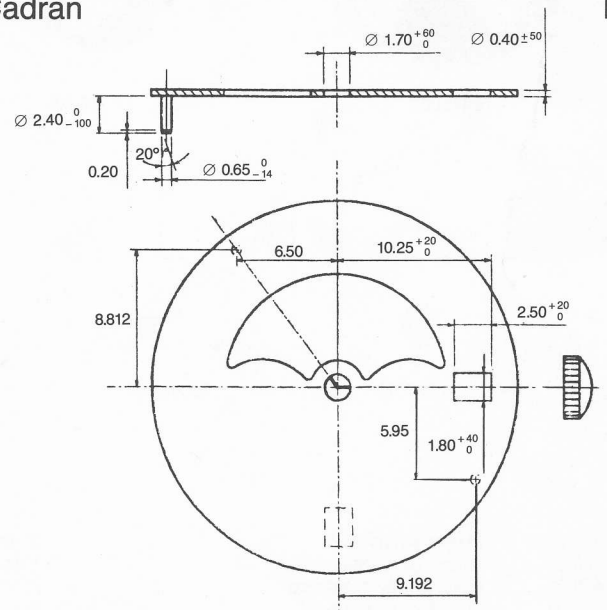
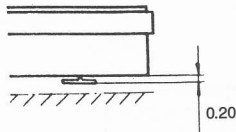

ISA

307/80

10 1/2

H 3,40



# FABRIQUE D'ÉBAUCHES DE SONCEBOZ S. A.

Division électronique Isaquartz

2068 Hauterive/Neuchâtel (Suisse)

C. P. 24 - Rouges-Terres 61 - Téléphone (038) 25 88 44 - Téléfax (038) 25 54 73

## 307/80

10 1/2

Mouvement électronique, quartz 32'768 Hz. Seconde centrale, une impulsion par seconde. Moteur rotatif pas à pas. Unité électronique asservie  
Calibre de base. - Quantième - Jour et nuit - Correcteur de quantième rapide intégral - Stop seconde - Stop moteur.

Electronic movement, quartz 32'768 Hz. Sweep second, one impulse per second. Rotary stepping motor.  
Base caliber. - Date - Sun and moon - Date quick correction integral - Stop second - Stop motor.

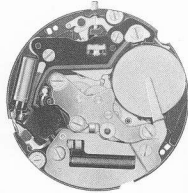

- 1: Repos - Rest
- 2: Quantième (correcteur rapide) - Date (quick corrector)
- 3: Aiguilles + quantième + indicateur jour et nuit - Stop  
Hands + date + sun and moon - Stop



### Pièces communes

### Commun parts

### Gemeinsame Teile

### 307/30/80



31.121.01

33.020.1

53.080.01



88.503.02

31.121.01 Pignon coulant  
 33.020.01 Roue entraîneuse de calendrier  
 53.080.01 Ressort sautoir de quantième  
 88.503.02 Vis de plaque de maintien (x3)

Sliding pinion  
 Date indicator driving wheel  
 Date jumper  
 Screw for maintaining plate (x3)

Kupplungstrieb  
 Datumanzeiger-Mitnehmerrad  
 Datumraste  
 Halteplatte-Schraube (x3)

Echelle 1,5: 1

### Jour et nuit

### Sun and moon

### Tag und Nacht

### 307/80

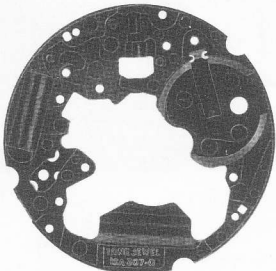

10.020.03



13.100.04

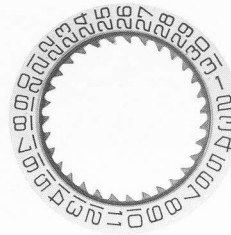

91.440.02



91.465.01



30.027.02



31.083.02



33.010.02



89.171.01



80.400.02

10.020.03 Platine synthétique  
 13.100.04 Plaque de maintien assemblée  
 91.440.02 Indicateur de quantième  
 91.465.01 Indicateur jour et nuit  
 30.027.02 Roue de seconde h = 4.81  
 31.083.02 Chaussée avec entraîneur h = 3.00  
 33.010.02 Roue des heures complète h = 1.87  
 89.171.01 Clavette de l'indicateur des jours  
 80.400.02 Tube de centre h = 2.90

Synthetic main plate  
 Assembled maintaining plate  
 Date indicator  
 Sun and moon indicator  
 Second wheel h = 4.81  
 Cannon pinion wheel h = 3.00  
 Hour wheel complete h = 1.87  
 Day indicator spring-clip  
 Center tube h = 2.90

Synthetisch Werkplatte  
 Halteplatte komplett  
 Datumanzeiger  
 Tag und Nacht Indikator  
 Sekundenrad h = 4.81  
 Minutenrohr mit Mitnehmer h = 3.00  
 Stundenrad komplett h = 1.87  
 Klemmscheibe für Tagesanzeiger  
 Zentrumlagerrohr h = 2.90

Echelle 1,5: 1